

# 3PHASE RAIL

IP20 230V/440V 16A

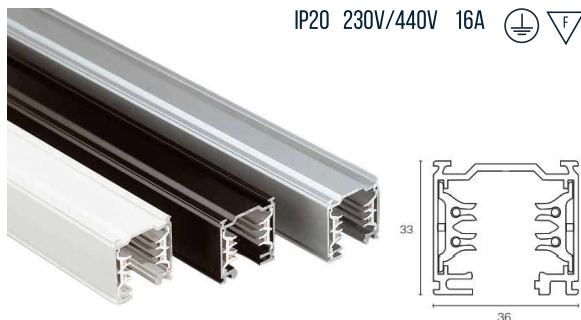

PRAGMALUX



## OPTIONS



	WHITE	BLACK	ALU
	○	●	●
1 meter	9041553	9041552	9041554
2 meter	9041556	9041555	9041557
3 meter	9041559	9041558	9041560

### LIVE-END

9042418	Right live-end Grey	●
9041613	Right live-end White	○
9041612	Right live-end Black	●
9042419	Left live-end Grey	●
9041615	Left live-end White	○
9041614	Left live-end Black	●

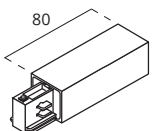

### L-JOINT

9042421	Inside L-joint Grey	●
9041621	Inside L-joint White	○
9041620	Inside L-joint Black	●
9042422	Outside L-joint Grey	●
9041623	Outside L-joint White	○
9041622	Outside L-joint Black	●

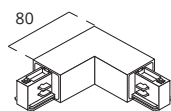

### CENTRAL CONNECTOR

9042420	Central connector Grey	●
9041617	Central connector White	○
9041616	Central connector Black	●

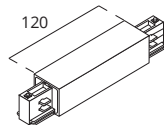

### UNIVERSAL ADAPTOR

9042407	Universal adaptor Grey	●
9041571	Universal adaptor White	○
9041570	Universal adaptor Black	●

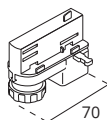

### UNIVERSAL ADAPTOR

9043529	Universal adaptor Grey	●
9043531	Universal adaptor White	○
9043530	Universal adaptor Black	●

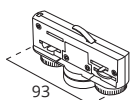

### MONOPOINT

9050300	Monopoint Grey	●
9050242	Monopoint White	○
9050241	Monopoint Black	●

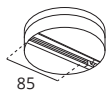

### END CAP

9042427	End cap Grey	●
9041633	End cap White	○
9041632	End cap Black	●



### MOUNTING BRACKET

9041589	Mounting bracket	●
---------	------------------	---



### STRENGTH PLATE 120MM

9041586	Strength plate 120mm	●
---------	----------------------	---

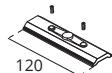

### SUSPENSION KIT, WIRE LENGTH 2M

9041588	Suspension kit plate 120mm	○
9041587	Suspension kit plate 120mm	●
9042675	Suspension kit plate 60mm with cable blocker	○
9042676	Suspension kit plate 60mm with cable blocker	●

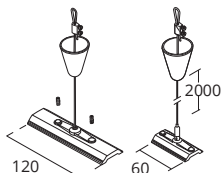

### T-JOINT

9042423	Right T-joint Grey	●
9041625	Right T-joint White	○
9041624	Right T-joint Black	●
9042424	Left T-joint Grey	●
9041627	Left T-joint White	○
9041626	Left T-joint Black	●

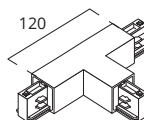

### X-JOINT

9042425	X-joint Grey	●
9041629	X-joint White	○
9041628	X-joint Black	●

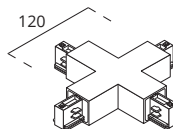

### FLEXIBLE JOINT

9042426	Flexible-joint Grey	●
9041631	Flexible-joint White	○
9041630	Flexible-joint Black	●
9044075	Flexible-joint Grey	●
9044076	Flexible-joint White	○
9044077	Flexible-joint Black	●

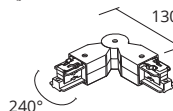
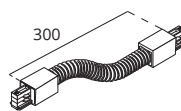

### ELECTRICAL / MECHANICAL JOINT

9041579	Electrical straight joint White	○
9041578	Electrical straight joint Black	●
9041619	Mechanical joint White	○
9041618	Mechanical joint Black	●

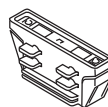

### TRACK COVER

9041603	Track cover 1m White	○
9041602	Track cover 1m Black	●



### MECHANICAL ADAPTOR

9041605	Mechanical adaptor White	○
9041604	Mechanical adaptor Black	●
9044078	Mechanical adaptor with cable blocker White	○
9044079	Mechanical adaptor with cable blocker Black	●
9044080	Mechanical adaptor with hook Grey	●
9044081	Mechanical adaptor with hook White	○
9044082	Mechanical adaptor with hook Black	●

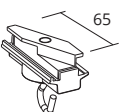
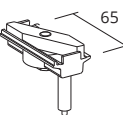
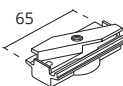

### SUSPENSION KIT, WIRE LENGTH 2.5M

9010210	Suspension kit plate 120mm with cable blocker and fixed ceiling mount	●
---------	---	---

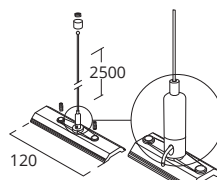

# WIRING DIAGRAMS

## SINGLE PHASE CONNECTION (230V)

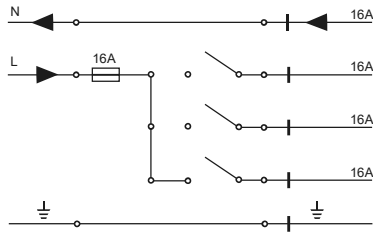

This allows a total load of 16A, corresponding to 3680 Watt, which can be divided among the 3 circuits.

## THREE PHASE CONNECTION (230V)

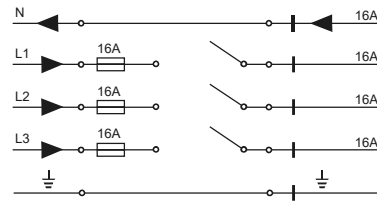

This allows a total load of 3x 16A, corresponding to 11040 Watt, which can be divided among the 3 circuits, 3x 3680 Watt.

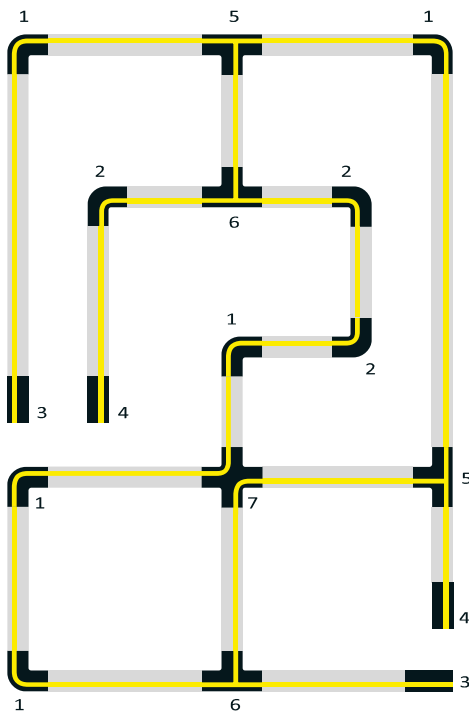

To install a three-phase track there is a wide range of parts available.

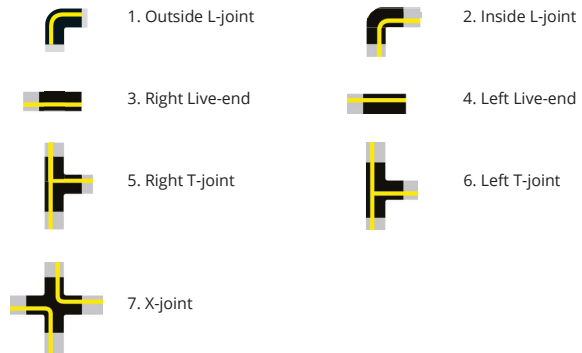

Live-end with earth on the left L

Live-end with earth on the right R

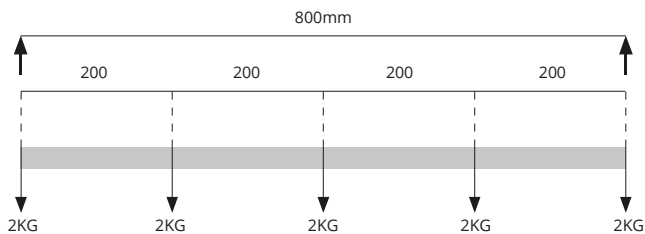

The three phase tracks can take a 2 KG load every 200mm, with a maximum distance of 800mm between the fixing points.

For a 5 KG load every 200mm, the maximum fixing distance has to be 400mm.

